

Table of Contents

Foreword

1. Installation Training	3	7. Adhesives	21
2. Product Descriptions	4	8. Installation	23
3. Application Chart	5	Linoleum Sheet	23
4. Fast Facts per Product	6	Linoleum Tile	30
Marmoleum Sheet	6	Heat Welding	34
Marmoleum Tile	7	Flash Coving	38
5. General Installation Guidelines	13	Repairs	42
Jobsite Conditions	13	9. Tools and Accessories	43
Material Storage and Handling	13	10. Warranty	46
Color Matching	13		
6. Substrate Evaluation and Preparation	14		
Definitions	14		
Substrate Evaluation	15		
Concrete Floors	15		
Wood Subfloors	15		
Existing Resilient Flooring	16		
Poured Floors	17		
Radiant Heated Floors	17		
Moisture Testing	17		
pH Testing	18		
Substrate Porosity	18		
Adhesive Bond Testing	19		
Substrate Preparation	19		
Patching and Leveling Materials	19		
Primers	20		
Existing Adhesives	20		
Additional Resources	20		
Specification Requirements	20		
Organizations	20		

FOREWORD

The finest floor covering made will not look good nor perform well if it is not installed properly. In the flooring industry, 97%-98% of all complaints are installation, subfloor or maintenance related.

The first step to a successful installation is choosing the right floor covering for the particular application. No one flooring is right for every application. If you have any doubt as to the suitability of a product, check with the manufacturer.

With today's technology, flooring products, substrate preparation products, adhesives and installation techniques change at a rapid pace. It is the responsibility of the installer to assure that the products are installed in strict adherence to the manufacturer's recommendations.

This installation manual is just one of the many technical support services provided by Forbo Flooring. Do not install any floor covering product until you are fully educated and familiar with installation procedures and recommendations, and have made sure that all site requirements have been met.

IMPORTANT!

The procedures described in this manual have been carefully developed to offer the best possible information for a proper and successful installation with Forbo's flooring products. Following these guidelines will offer the consumer the full value of the manufacturer's warranty. Any deviation from these instructions may result in an installation failure. Failure to follow these guidelines does not affect the manufacturer's limited five year warranty, but it does increase the chance of an installation failure.

Installation Training

PROFESSIONALISM AND ATTITUDE

“Professionalism” is not merely possessing mechanical skills and knowledge it is also an attitude. Having the right attitude and conducting yourself in a professional manner at all times is essential to gaining the respect of all those you come into contact with. Above all else, taking pride in your work is the key to successful installations.

Take the time to review the manufacturer’s installation guidelines. If you ever have any doubts, do not proceed with the installation. Call your local supplier for further information. The liability of the installation rests solely with the installer and flooring contractor. The warranty from the manufacturer covers only the product, and is in no way contingent upon installation and maintenance practices.

PROFESSIONALISM AND EDUCATION

The flooring industry is continually changing. In order to remain successful, those working in the industry must also change. Education is the key to this change.

The Forbo Associate and Master Mechanic courses are benchmarks for installation training. In addition to being dedicated to offering the resilient flooring installer the most comprehensive and professional installation training courses in the industry, Forbo Flooring also offers an array of other educational opportunities such as product presentations, supplier training seminars, and dealer installation clinics for flooring products, Moisture Limitor, and Bulletin Board Cork.

Forbo Flooring installation training courses are PASS/FAIL. In order to qualify for a certificate, the installer must successfully and satisfactorily complete the installation tasks, have a thorough knowledge of the information presented throughout the course, and most importantly, demonstrate a professional attitude.

Upon successful completion of the course, the installer will receive a certificate suitable for framing, a laminated wallet card to carry, and a patch that can be sewn on a shirt, jacket, etc. Qualified installers are maintained in a database utilized for referrals throughout North America.

Forbo Flooring, Inc.
Technical Services
P.O. Box 667
Hazleton, PA 18201
Email: info@fL-NA.com
Website: www.forboflooringNA.com
Tel: (570) 459-0771
Fax: (570) 450-0330
Toll Free: 800-842-7839

ASSOCIATE MECHANIC PROGRAM

Forbo’s ASSOCIATE MECHANIC installation training covers a range of topics and techniques including:

- subfloor evaluation and preparation
- Moisture Limitor certification
- product knowledge
- tools
- fitting methods
- Marmoleum installation
- seaming
- repairs
- heatwelding
- maintenance
- PROFESSIONALISM



This training is designed for experienced resilient flooring installers who desire to improve their level of knowledge and skill.

MASTER MECHANIC PROGRAM

Forbo’s MASTER MECHANIC installation training is tailored for the Forbo Associate Mechanic who desires to reach the highest level in his trade. This intensive and rewarding course covers a range of advanced installation topics and techniques including:

- wall installations
- accent heat welding
- specialty tools
- flash coving
- heatwelding flashcove seams and corners
- inset and design installations
- PROFESSIONALISM



TRAINING CENTERS

Associate and Master Mechanic installation training is offered at Forbo’s technical training centers in the following locations:

- Hazleton, PA
- Reno, NV
- Dallas, TX

Forbo will provide all meals, hotel accommodations and transportation to/from our facilities and the Wilkes Barre/ Scranton airport for our Pennsylvania center; Reno International airport for our Reno center; DFW Airport or Love Field for our Texas center.

If you are a professional and desire to enhance your skills and knowledge, contact Forbo or your local supplier for course dates and an application form.

marmoleum® fast facts

Marmoleum sheet

Description: Marmoleum from Forbo Flooring is made from primarily natural ingredients which consist of oxidized linseed oil, rosins, cork and/or wood flour, all of which are calendered onto a carrier sheet. Depending on the calendering method used and the composition, various types of linoleum can be manufactured. Marmoleum sheet is calendered onto a jute back.

GAUGE: 1/10" (2.5 mm)

WIDTH: 79" (2 meters)

LENGTH: 105' (32 meters)

INSTALLATION FAST FACTS

- Marmoleum may be installed on approved substrates on all grade levels.
- The permanent HVAC must be operational and set at a minimum of 68° F (20° C) at least one week prior to installation. Acclimate material to jobsite conditions for a minimum of 48 hrs. prior to installation.
- Always conduct moisture tests on all concrete slabs regardless of age or grade level.
- Conduct calcium chloride tests in accordance with ASTM F1869. Concrete moisture vapor emissions must not exceed 5.0 lbs. per 1000 sq. ft. in 24 hrs. when using Forbo L910 adhesive, or 3.0 lbs per 1000 sq. ft. in 24 hrs. when using Forbo 414 adhesive (available in Canada only). When moisture vapor emissions exceed these requirements, please request information on Forbo Moisture Limitor.
- Measure the relative humidity in the center of the concrete slab in accordance with ASTM F2170. Relative humidity must not exceed 75%.
- A pH test should be conducted and must not exceed a pH of 10.
- Always use the highest quality patching and leveling compounds and always follow the manufacturer's recommendations for their use and application.
- Always conduct an adhesive mat bond test. Bond testing will aid in determining the proper working time of the adhesive and identify bonding problems prior to the installation.
- Use Forbo L910 adhesive or Forbo 414 adhesive (available in Canada only) for flat installations and when coving material.
- Use a 1/16" x 1/16" x 1/16" square notch trowel.
- Install rolls and cuts in consecutive order. Do Not Reverse sheets for seaming.
- Install one sheet at a time, making sure to place the material into wet adhesive. Roll immediately with a 100 lb. roller and always check for proper adhesive transfer. In order to achieve a secure bond there must be a complete wet transfer of adhesive to the material backing.
- Underscribe seams and cut material on a slight bevel; refer to seaming procedures.
- Flat trowel adhesive on the material backing in the area of stove bar marks (double stick), and weigh down after rolling.
- Heat welding is optional; but recommended. Use Marmoweld or Artoweld welding rod only. Do not chemical weld.
- Do not allow heavy traffic or rolling loads for a minimum of 72 hours following the installation. Additional time may be necessary when installing over non-porous substrates.
- In order to allow the adhesive to dry and cure properly, wait at least five days following the installation before conducting wet cleaning procedures or initial maintenance. Additional time may be necessary when installing over non-porous substrates.
- These are just "Fast Facts". Complete installation instructions can be found in other sections of this manual. For additional information, contact Forbo Technical Services at (800) 842-7839.

marmoleum[®] tile fast facts

Marmoleum tile

Description: Marmoleum from Forbo Flooring is made from primarily natural ingredients which consist of oxidized linseed oil, rosins, cork and/or wood flour, all of which are calendered onto a carrier sheet. Depending on the calendering method used and the composition, various types of linoleum can be manufactured. Marmoleum Tile is calendered onto a dimensionally stable polyester backing.

GAUGE: 1/10" (2.5 mm)

TILE SIZE: 13" x 13" approximately (33 cm x 33 cm)

INSTALLATION FAST FACTS

- Marmoleum Tile may be installed on approved substrates on all grade levels.
- The permanent HVAC must be operational and set at a minimum of 68° F (20° C) at least one week prior to installation. Acclimate material to jobsite conditions for a minimum of 48 hrs. prior to installation.
- Always conduct moisture tests on all concrete slabs regardless of age or grade level.
- Conduct calcium chloride tests in accordance with ASTM F1869. Concrete moisture vapor emissions must not exceed 5.0 lbs. per 1000 sq. ft. in 24 hrs. when using Forbo T940 adhesive, or 3.0 lbs per 1000 sq. ft. in 24 hrs. when using Forbo 414 adhesive (available in Canada only). When moisture vapor emissions exceed these requirements, please request information on Forbo Moisture Limitor.
- Measure the relative humidity in the center of the concrete slab in accordance with ASTM F2170. Relative humidity must not exceed 75%.
- A pH test should be conducted and must not exceed a pH of 10.
- Always use the highest quality patching and leveling compounds and always follow the manufacturer's recommendations for their use and application.
- Always conduct an adhesive mat bond test. Bond testing will aid in determining the proper working time of the adhesive and identify bonding problems prior to the installation.
- Use Forbo T 940 adhesive, or Forbo 414 adhesive (available in Canada only).
- Use a 1/16" x 1/16" x 1/16" square notch trowel.
- Install cartons in consecutive order.
- Install tile in alternating directions (quarter turned).
- Install tiles into wet adhesive and roll immediately with a 100 lb. roller. Always check for proper adhesive transfer. In order to achieve a secure bond there must be a complete wet transfer of adhesive to the tile backing.
- Heat welding is optional. Use Marmoweld welding rod only. Do not chemical weld.
- Do not allow heavy traffic or rolling loads for a minimum of 72 hours following the installation. Additional time may be necessary when installing over non-porous substrates.
- In order to allow the adhesive to dry and cure properly, wait at least five days following the installation before conducting wet cleaning procedures or initial maintenance. Additional time may be necessary when installing over non-porous substrates.
- These are just "Fast Facts". Complete installation instructions can be found in other sections of this manual. For additional information, contact Forbo Technical Services at (800) 842-7839.

Subfloors

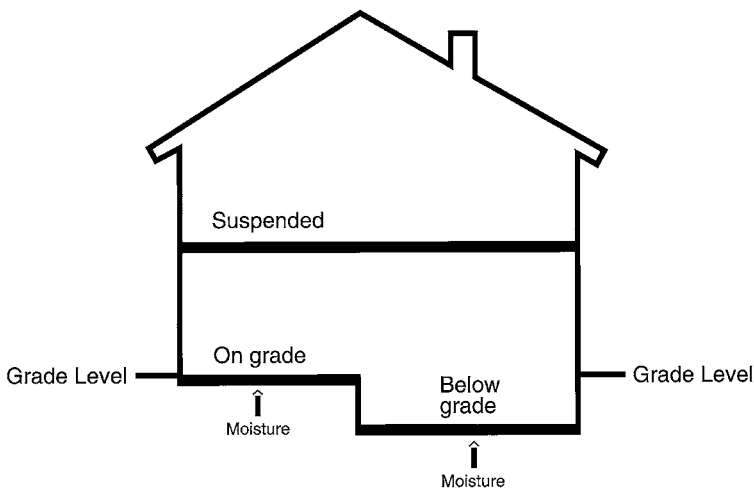

No floor covering can be any better than the substrate over which it is installed. The finished appearance and performance of the floor covering will be determined and affected by the condition of the substrate. It is essential that all substrates be structurally sound, rigid, smooth, flat, clean, and permanently dry. The substrate surface must be free of all contaminants or foreign materials such as dust, wax, paint, grease, oils, solvents, curing and hardening compounds, sealers, and existing adhesives. Substrate evaluation and preparation should not begin until a stable, conditioned environment as described under Jobsite Conditions has been established.

NOTE: The results of moisture testing, pH testing, and adhesive bond testing are directly influenced by the environment in which the tests are conducted. Results of tests conducted prior to establishing a stable, conditioned interior environment should not be relied upon for determining if suitable conditions exist for installation of resilient flooring materials. Changes in the interior environment subsequent to such testing may cause conditions to change and lead to installation failures.

Grade Levels:

On Grade – A location for a finished floor with no portion below ground level, and with the floor and the ground in contact or separated by less than 18 inches of well-ventilated space between the bottom of the lowest horizontal structural member and the ground at any point.

Above Grade (Suspended) – A location for a finished floor where the floor is not in contact with the ground and which provides at least 18 inches of well-ventilated space between the bottom of the lowest horizontal structural member and the ground at any point.

Below Grade – A location for a floor structure which is in contact with the ground or with less than 18 inches of well-ventilated space between the bottom of the lowest horizontal structural member and the ground, at any point and if part or all of the floor is below ground level.

Definitions:

Subfloor – that structural layer intended to provide support for design loadings which may receive resilient floor coverings directly if the surface is suitable or indirectly via an underlayment if its surface is not suitable.

Underlayment – The layer of material installed on or over the subfloor to provide a smooth, clean surface to receive the resilient floor covering.

Substrate - the underlying support surface upon which the flooring is directly installed.

Subfloor–Underlayment Combination – Designed to meet both the structural requirements and to provide a smooth surface to receive the floor covering.

• **Note:** Subfloor-Underlayment Combinations are usually only suitable for the installation of textile type floor coverings. For resilient floor coverings, underlayment should be installed.

Flooring System – All components associated with the installation of flooring materials including, but not limited to, subfloors, substrates, patching and leveling materials, primers or other coatings, moisture control products, adhesives, and finish flooring materials.

(Refer to ASTM F141 for additional definitions)

Subfloors

SUBSTRATE EVALUATION

Concrete Subfloors (Refer to ASTM F710)

Concrete substrates shall be structurally sound, rigid, smooth, flat, clean, and permanently dry. The concrete surface must be free of all contaminants or foreign materials such as dust, paint, wax, grease, oils, solvents, curing and hardening compounds, sealers, and existing adhesives.

Concrete substrates shall have a minimum compressive strength of 3500 psi and a dry density of at least 150 pounds per cubic foot.

Concrete subfloors on or below grade shall have an acceptable vapor retarder underneath. The vapor retarder shall be puncture and tear resistant with a minimum thickness of 15 mils, and have a permeability rating of 0.3 perms or less. Refer to ASTM E1745. If no vapor retarder is present, contact Forbo Technical Services for additional information.

Imperfections such as chips, spalls, cracks, and joints must be repaired using suitable patching and leveling materials. Always follow the manufacturer's recommendations for the use and application of these products. (see Substrate Preparation)

Concrete Joints

Expansion and isolation joints - expansion and isolation joints in concrete are designed to allow for the expansion and contraction of the concrete. All movable joints must be honored in order to eliminate buckling and telegraphing in the finished resilient flooring caused by movement in the concrete. Expansion joint covers designed for use with resilient floorings must be used at all movable joints.

Construction and Control Joints (sawcuts) - all such non-moving joints should be prepared using suitable fillers and/or patching and leveling materials. Always follow the manufacturer's recommendations for the use and application of these products. (see Substrate Preparation)

Note: If movement in the concrete and/or moisture coming from the joint subsequent to the installation of resilient flooring materials causes buckling of the flooring material or telegraphing of the joint, it is a structural or site related condition. Any such damage resulting from those conditions is not covered under Forbo's warranty. Having the areas to receive floorcoverings conditioned as described under Jobsite Conditions will reduce the potential for such occurrences.

It may be difficult to determine if curing compounds, hardening compounds, and/or sealers have been used. Always conduct adhesive bond tests prior to the installation to ensure the integrity of the flooring system, and to ensure that a secure bond can be achieved.

Wood Subfloors (Refer to ASTM F1482)

Wood substrates shall be structurally sound, rigid, smooth, flat, clean, and permanently dry. The wood surface must be free of all contaminants or foreign materials such as dust, paint, wax, grease, oils, solvents, curing and hardening compounds, sealers, and existing adhesives.

Wood subfloors should be double construction with a minimum total thickness of 1". All wood subfloors must have at least 18" of well-ventilated air space below.

Forbo floor coverings should not be installed over wooden subfloors built on sleepers over on grade or below grade concrete floors without first making sure that adequate precautions have been taken to ensure the structural integrity of the system, and to prevent moisture migration from the concrete slab. Proper planning and design will minimize the potential for flooring system failures generally associated with this type of construction.

Strip Wood/Plank Flooring

Because of the expansion and contraction of strip and plank flooring during seasonal changes, 1/4" or thicker underlayment panels must be installed over these types of floors.

Underlayment Panels

Underlayment panels are used to correct deficiencies in the subfloor and to provide a smooth, sound surface on which to adhere resilient flooring. Underlayment panels should be acclimated to site conditions as prescribed by the manufacturer. In lieu of specific recommendations, acclimate panels for a minimum of 48 hours prior to installation.

Underlayment panels should be a minimum of 1/4" in thickness, of underlayment grade with one fully sanded face, and recommended for use as underlayment for fully adhered resilient flooring (APA Underlayment Grade plywood or equal). Underlayment panels must be free of any foreign material that may prohibit a secure bond or cause the discoloration of resilient flooring, such as adhesives, sealers, inks, solvents, etc.

Always follow the panel manufacturer's recommendations for panel installation and preparation. In lieu of specific installation recommendations, successful panel installation may be accomplished as follows:

Using narrow crown, divergent point staples that will not extend completely through the subfloor, begin fastening the panel in one corner and proceed in a fan pattern across the panel. Place staples four to six inches apart in the middle of the panel and two to three inches apart at the panel edges.

Subfloors

Staples should be no closer than 3/8" from the panel edge. Panels should be lightly butted, with no pressure. After fastening, sand all panel joints flush.

Years of experience have identified a number of wood substrates that may cause problems when resilient flooring products are installed over them. Installation of Forbo flooring products is NOT recommended over particle board/chip board, tempered hardboard, luan plywood, fire retardant plywood, or pressure treated plywood.

Always conduct adhesive bond tests prior to the installation to ensure the integrity of the flooring system, and to ensure that a secure bond can be achieved.

Regardless of the type or brand of underlayment used, any problems or failures directly related to the performance of the underlayment is the responsibility of the underlayment manufacturer and/or installation contractor, and not Forbo.

Note: The use of a skim coat of patching material over wooden substrates may cause more problems than it resolves, especially in the joint areas. Moisture from patching materials will be absorbed by the wood, causing the wood fibers to swell and potentially causing the panel surface and/or joints to telegraph through the newly installed floor covering. Proper installation of a wooden subfloor and underlayment panels is critical to the successful installation of resilient flooring.

Existing Resilient Flooring

Forbo floor coverings installed over existing resilient flooring may be more susceptible to indentation, and there is always the possibility that the existing flooring may telegraph through the new flooring.

Forbo floor coverings may be installed over a single layer of non-cushioned resilient flooring provided it meets the following conditions:

1. Where existing resilient flooring is installed over concrete that is on, above and below grade, there should be no history of moisture related problems and moisture test results must not exceed the requirements of the existing resilient flooring or the product to be installed (see Moisture Testing).
2. The substrate and underlayment must meet the requirements of the existing and the new floor covering.
3. The existing flooring must be fully adhered and well bonded.
4. The existing flooring must not be embossed or textured.

5. All cuts, gouges, dents, and other damage must be repaired with flooring material that is the same or similar to that installed, or with patching materials suitable for that purpose. Always follow manufacturer's recommendations for use and application of patching materials.
6. All waxes and finishes must be removed from the existing resilient flooring, and the surface rinsed with clean water. After cleaning, pH tests should be conducted to assure stripper residues have been removed.

The use of embossing levelers is not recommended for commercial installations.

Note: Application of a skim coat of patching material over the existing resilient flooring may cause more problems than it resolves; such as bonding failures, cracking and indentations.

Always conduct adhesive bond tests prior to the installation to ensure the integrity of the flooring system, and to ensure that a secure bond can be achieved.

The responsibility for determining if the existing resilient flooring is suitable to be installed over rests solely with the installer and flooring contractor. If there is any doubt as to its suitability, the existing flooring should be removed or an acceptable underlayment installed over it.

WARNING!

DO NOT SAND, DRY SWEEP, DRY SCRAPE, DRILL, SAW, BEADBLAST, OR MECHANICALLY CHIP OR PULVERIZE EXISTING RESILIENT FLOORING, BACKING, LINING FELT OR ASPHALTIC "CUT-BACK" ADHESIVES. THESE PRODUCTS MAY CONTAIN EITHER ASBESTOS FIBERS OR CRYSTALLINE SILICA. AVOID CREATING DUST. INHALATION OF SUCH DUST IS A CANCER AND RESPIRATORY TRACT HAZARD. SMOKING BY INDIVIDUALS EXPOSED TO ASBESTOS FIBERS GREATLY INCREASES THE RISK OF SERIOUS BODILY HARM. UNLESS POSITIVELY CERTAIN THAT THE PRODUCT IS A NON-ASBESTOS CONTAINING MATERIAL, YOU MUST PRESUME IT CONTAINS ASBESTOS. REGULATIONS MAY REQUIRE THAT THE MATERIAL BE TESTED TO DETERMINE ASBESTOS CONTENT. THE RCF'S RECOMMENDED WORK PRACTICES FOR REMOVAL OF RESILIENT FLOOR COVERINGS ARE A DEFINED SET OF INSTRUCTIONS WHICH SHOULD BE FOLLOWED IF YOU MUST REMOVE EXISTING RESILIENT FLOOR COVERING STRUCTURES.

Subfloors

Poured Floors (Epoxy, Polymeric, Seamless)

Forbo floor coverings may be installed over most poured floors provided they meet the following conditions:

1. Where poured flooring is installed over concrete that is on, above and below grade, there should be no history of moisture related problems and moisture test results must not exceed the requirements of the existing resilient flooring or the product to be installed (see Moisture Testing).
2. The poured floor must be totally cured and well bonded to the concrete. It must be free of any residual solvents and petroleum derivatives.
3. Loose, damaged areas and irregularities must be repaired with a patching compound suitable for that purpose. Always follow manufacturer's recommendations for use and application of patching materials.
4. The texture must be smooth. Sand or wet stone the surface to remove any grit and texture.
5. All waxes and finishes must be removed from the existing resilient flooring, and the surface rinsed with clean water. After cleaning, pH tests should be conducted to assure stripper residues have been removed.

Always conduct adhesive bond tests prior to the installation to ensure the integrity of the flooring system, and to ensure that a secure bond can be achieved.

The responsibility for determining if the existing flooring is suitable to be installed over rests solely with the installer and flooring contractor. If there is any doubt as to its suitability, the existing flooring should be removed or an acceptable underlayment installed over it.

Radiant Heated Floors

Forbo floor coverings may be installed over radiant heated floors providing the maximum temperature of the surface of the substrate does not exceed 85°F (29°C) under any condition of use. To enable a secure bond of the adhesive to the substrate, the radiant heating system should be turned off, or the temperature lowered, for at least 48 hours prior to installation of the Forbo flooring material. This is to ensure the surface temperature of the substrate does not exceed 65o F during the installation of the flooring material.

If necessary, an alternate heating source must be used to maintain the room temperature a minimum of 68o F prior to, during, and for 72 hours after installation. 72 hours following the installation, the temperature of the radiant heating system can be increased. When raising the floor temperature, do so gradually so that the substrate and flooring material can adapt to the temperature change together. A rapid temperature change could result in bonding problems. For more information, contact Forbo Technical Services.

Moisture Testing

It is essential that moisture tests be taken on ALL concrete slabs regardless of age or grade level, including those where resilient flooring has already been installed. Moisture tests should not be conducted unless a stable, conditioned environment as described under Jobsite Conditions has been established.

The environment in which the tests are conducted directly influences moisture test results. Results of tests conducted prior to establishing a stable, conditioned interior environment should not be relied upon when determining if suitable conditions exist for installation of resilient flooring materials. Changes in the interior environment subsequent to such testing may cause conditions to change and lead to installation failures.

Forbo recommends that two types of moisture testing be conducted:

1. Calcium Chloride Moisture Vapor Emission Testing
Testing should be done in accordance with ASTM F1869. The moisture vapor emissions from the concrete must not exceed the requirements of the flooring product(s) and adhesive(s) being used.

When conducting calcium chloride moisture vapor emission tests, unreliable or erroneous test results are most often the result of:

- Conducting tests in an uncontrolled environment.
- Failure to properly prepare the concrete surface. Any existing flooring and/or adhesive must be completely removed prior to testing.
- An inadequate seal between the dome and the concrete surface.
- Not subtracting the area of the calcium chloride dish when calculating results.
- Lack of proper documentation and reporting.

2. Relative Humidity Probe Testing

Testing should be done in accordance with ASTM F2170. The relative humidity measured from the center of the concrete slab must not exceed 75%.

When conducting relative humidity probe tests, unreliable or erroneous test results are most often the result of:

- Conducting tests in an uncontrolled environment.
- Failure to ensure that the drilled hole was properly sealed.
- Test equipment that has not been properly acclimated to site conditions
- Test equipment out of calibration. Equipment should have an accuracy of +/- 3%.
- Lack of proper documentation and reporting.

Subfloors

A minimum of three tests of each type should be conducted on every job. On larger jobs, an additional test of each type should be conducted for each additional 1,000 sq. ft. over 1,000 sq. ft. of flooring to be installed. A diagram of the area showing the location of each test and the corresponding test results should be submitted to the architect, general contractor and end user prior to the installation of the flooring material. If any test result exceeds the limitations specified, the installation SHOULD NOT PROCEED until the problem has been corrected. Installation of Forbo flooring products where moisture conditions exceed specified limits may result in partial or complete failure, and any damage or failure caused by excessive substrate moisture is the responsibility of others, and not Forbo. Failure to honor this recommendation is an implied acceptance of site conditions by the parties involved.

Moisture tests indicate conditions at the time of the test only. The absence of an acceptable vapor retarder under the slab, changes in the environment, or other circumstances beyond Forbo's control, may lead to adverse changes in the moisture condition of the concrete. Forbo's warranty shall not be extended to cover damage or failures caused by moisture conditions in excess of specified limits that occur after the time of initial testing or installation.

pH Testing

It is essential that pH tests be conducted on all concrete floors regardless of the age or grade level. During the curing and drying of concrete, or whenever moisture is present and working its way through the concrete, moisture will dissolve alkali salts that are contained in the concrete. When the moisture reaches the surface of the concrete it evaporates, leaving behind an alkali salt residue on the surface. These alkali salts may cause several installation and material problems, such as adhesive failure or discoloration, shrinkage, and softening of the floor covering.

Testing the concrete pH should be done in several locations throughout the area to receive flooring. The best rule to follow is to conduct pH tests at each calcium chloride test location as the calcium chloride tests are removed. Conduct the pH test by placing a small drop of distilled or de-ionized water on the surface of the concrete. The concrete surface should remain wet for a minimum of 60 seconds; the more porous the concrete, the larger the drop should be. Slight agitation of the surface of the concrete may be necessary to ensure that any alkaline salts have dissolved into the water. Place a full range pH test strip in the water and wait until the color stops changing. Compare the color of the test strip to the chart that comes with the test strips. If the pH is greater than 10, it must be reduced prior to beginning the installation. Lightly abrading the surface and vacuuming up the residue will often reduce the concrete surface pH. Retest

to assure the pH has been reduced. There are also commercially available pH blockers. Check with your local flooring supply house, or in trade publications for availability of these products.

Substrate Porosity

Substrate porosity has a significant influence on the working characteristics of adhesives (open time and working time). It is important for the installer to recognize and understand this relationship so that adhesives will be used properly, especially for "wet set" installations. Where the substrate is non-porous, very porous, or if substrate porosity is not uniform, adjustments will have to be made in installation procedures to compensate. Where the substrate is less porous, the adhesive will dry more slowly, extending the "open time" required to allow the adhesive to develop "body" before placing the material. Where the substrate is more porous, the adhesive will dry more rapidly and may require that the adhesive be applied incrementally so that the material can be placed and rolled while the adhesive is still wet enough to achieve the transfer necessary for a secure bond. It is the installer's responsibility to recognize the working characteristics of the adhesive for a given situation, and make any necessary adjustments in preparation or installation techniques that may be required to achieve a secure bond.

An easy way to determine the porosity of the substrate is to use a drinking straw or eye-dropper of water, and place a row of water drops on the surface of the substrate. If within 60 seconds the drops are not absorbed into the substrate, the substrate should be considered non-porous.

If a concrete substrate is non-porous, a curing compound, hardener, sealer, or other bond inhibiting material may be present. Conducting an adhesive bond test will aid in identifying such contaminants.

Abrading the surface of uncontaminated, non-porous substrates may be necessary to achieve a secure bond. Primers may also be useful in improving the adhesive bond to smooth, non-porous substrates. For very porous substrates, a primer may be useful for reducing the substrate porosity and improving the working characteristics of the adhesive. A primer may also be necessary to provide a uniform porosity over surfaces where substrate porosity is inconsistent. (see Primers)

Always conduct adhesive bond tests prior to the installation to ensure the integrity of the flooring system, and to ensure that a secure bond can be achieved.

Subfloors

Adhesive Bond Testing

Adhesive bond testing will identify most potential bonding problems and is essential for ensuring the integrity of the flooring system prior to the installation. Adhesive bond tests should be conducted using the adhesive(s) and material(s) to be used on the project after all remediation and/or preparation work has been completed. Adhesive bond tests should also be used to evaluate test areas for proposed remediation or preparation procedures.

Conduct adhesive bond tests by adhering 3' X 3' squares of material in various locations throughout the area where flooring is to be installed. The number of tests required will vary, but should be representative of evaluating the entire surface where material will be installed. Be sure to conduct tests where patching/leveling materials have been used, or anywhere moisture control systems or primers have been used. Allow the adhesive to dry for a minimum of 72 hrs., and then remove the test squares.

Interpreting the results of an adhesive bond test will vary depending on the substrate, adhesive, and the flooring material used. Generally, when using Forbo single component adhesives over standard substrates (concrete, wood, existing flooring) and following "wet set" installation recommendations, the bond failure should occur within the adhesive layer when the test sample is removed. There should be approximately the same amount of adhesive on the substrate and the material backing. If all or most of the adhesive is on the material backing, there is very likely a contaminant on the substrate. If all or most of the adhesive remains on the substrate, the adhesive most likely dried too much before placing the material, or the material was not rolled properly. If the failure occurs within or between other components of the flooring system, there may be a problem with those components.

Note: When evaluating adhesive bond tests using Forbo T940 adhesive and Marmoleum Dual Tile, the failure will generally occur between the adhesive and the tile backing rather than within the adhesive layer. This is normal so long as significant force is required to remove the test sample, and the impression of the tile backing can be readily seen in the adhesive layer. The tile must be fully bedded in the adhesive with no significant appearance of trowel ridges.

There is no standard criteria for evaluating adhesive bond tests, but a bond test is generally considered "passed" when there is no apparent "bond failure" within any component of the flooring system, and the force required to remove the test sample is judged adequate to provide satisfactory performance of the flooring system for the intended application. For additional information, contact Forbo Technical Services.

It is the installer's responsibility to identify and correct potential bonding problems and to ensure that a satisfactory bond can be achieved prior to beginning the installation.

SUBSTRATE PREPARATION

Vacuuming the substrate with a commercial shop vacuum is the preferred method of removing dirt and dust. For concrete floors, damp mopping the substrate is an excellent way to remove fine dust. A clean substrate enables a secure bond between the substrate and the floor covering.

Patching and Leveling Materials

There are basically two categories of patching and leveling materials available in the marketplace. One category is calcium sulfate/ plaster/ gypsum base compounds, and the other is portland cement based compounds.

Historically, the use of gypsum based materials has been discouraged by resilient flooring manufacturers because of performance concerns such as lower compressive strength, bonding issues, and the potential for promoting the growth of mold and mildew. Improvements in technology however, have led to the development of gypsum based leveling compounds in particular, that have much improved performance characteristics than earlier products.

There are a wide range of patching and leveling materials currently available for the purpose of smoothing and patching substrate irregularities and their quality and performance will vary. The user of such products should research performance specifications and warranties, and choose only the highest quality materials when installing Forbo flooring products. All guidelines and recommendations from the manufacturer of the product chosen should be strictly followed.

Regardless of the type or brand of patching or leveling material used, any liability for the performance of the patching or leveling material rests with the product manufacturer and/or applicator, and not Forbo.

Always conduct adhesive bond tests prior to the installation to ensure the integrity of the flooring system, and to ensure that a secure bond can be achieved.

Primers

The use of a primer may be necessary to improve adhesive bond to extremely smooth, non-porous substrates such as terrazzo, existing resilient flooring, or power troweled concrete. A primer may also be necessary to reduce the porosity of extremely porous substrates, or to create a uniform porosity where spot patching has been done over a non-porous substrate for example.

Subfloors

Forbo Moisture Limitor may be used as a primer. Refer to Moisture Limitor guidelines for complete instructions. There are also third party products available for this purpose. Always strictly follow the manufacturer's recommendations for their use and application.

Always conduct adhesive bond tests prior to the installation to ensure the integrity of the flooring system, and to ensure that a secure bond can be achieved.

Existing Adhesives

Warning!

Warning Regarding Complete Adhesive Removal: Some Solvent Based Asphaltic "Cut-Back" Adhesives May Contain Asbestos Fibers That Are Not Readily Identifiable. Do Not Use Power Devices Which Create Asbestos Dust in Removing These Adhesives. The Inhalation of Asbestos Dust May Cause Asbestosis or Other Serious Bodily Harm. Smoking Greatly Increases the Risk of Serious Bodily Harm.

- Never use solvents or adhesive removers to remove old adhesive residue. Any residue left within the substrate may affect the new adhesive and new floor covering. Conducting pH tests and adhesive bond tests prior to the installation will help in identifying the possible use of these materials.

Where existing asphaltic (cut-back) or other type of adhesive is present, it must be dealt with in one of 3 ways:

1. It may be mechanically removed by grinding, bead blasting, scarifying, etc.
2. The adhesive residue* may be encapsulated with a suitable self-leveling underlayment. Follow the self-leveling manufacturer's recommendations for intended use and application.
3. The adhesive residue* may be encapsulated with Forbo Moisture Limitor. Refer to Moisture Limitor guidelines for complete instructions.

* Residue is defined as residual staining that is left after all adhesive has been scraped away down to the concrete surface.

ADDITIONAL RESOURCES

Specification Requirements/Reference Documents

Reference documents for proper specification requirements are:

- ACI 302--Guide for Concrete Floor Construction
- ASTM E1745--Specification for Vapor Retarders
- ASTM F1482 - Standard Guide to Wood Underlayment Products Available for Use Under Resilient Flooring
- ASTM F710--Preparing Concrete Floors to Receive Resilient Flooring

Organizations

Additional information and guidelines regarding substrates and substrate preparation can be obtained by contacting the following organizations:

APA - The Engineered Wood Association
7011 So. 19th, Tacoma, WA 98466
(253) 565-6600 / Fax: (253) 565-7265
www.apawood.org

ACI - American Concrete Institute
P.O. Box 9094
Farmington Hills MI 48333
(248) 848-3700
www.aci-int.net

PCA - Portland Cement Association
5420 Old Orchard Rd.
Skokie, IL 60077
(847) 966-6200 / Fax: (847) 966-8389
800-868-6733
www.cement.org

RFCI - Resilient Floor Covering Institute
401 E. Jefferson Street, Suite 102
Rockville, MD. 20850
(301) 340-8580
www.rfci.com

ASTM - American Society for Testing and Materials
100 Barr Harbor Drive
West Conshohocken, PA 19428-2959
(610) 832-9585 / Fax: (610) 832-9555
www.astm.com

Adhesives

Adhesives are formulated for specific products and applications; use only Forbo adhesives for the installation of Forbo flooring products. In order to achieve a successful bond, it is essential that all substrates, regardless of type, be structurally sound, rigid, smooth, flat, clean, and permanently dry. The substrate surface must be free of all contaminants or foreign materials such as dust, wax, paint, grease, oils, solvents, curing and hardening compounds, sealers, and existing adhesives. Always carefully read and follow the instructions on the adhesive label regarding the use and application of the adhesive, and always review and follow safety and health warnings included on the label and MSDS.

NOTE: Any claim submitted to Forbo Flooring regarding bonding issues will be rejected if an adhesive not supplied by Forbo was used.

ADHESIVE APPLICATION

“Open time” is the amount of time that the adhesive must remain exposed to the air before the flooring material can be laid into it. “Working time” is the amount of time that remains after the open time has expired to successfully complete the installation. The actual open time and working time of adhesives is determined by the ambient air temperature and humidity, the amount of air circulation, the substrate type and porosity, the working characteristics of the adhesive being used, and the trowel notch being used. Adjustments to recommended open and working times might be necessary as site conditions vary.

A trowel is a metering device that regulates the amount of adhesive being applied. Always apply the adhesive with a trowel that has the flooring manufacturer’s recommended notch for the flooring product being installed. Using the recommended trowel notch ensures that the proper amount of adhesive is applied. The use of an improperly notched trowel will apply too much or too little adhesive, and can cause bonding problems, telegraphing, indentations, and inadequate working time, all of which may result in an installation failure.

NOTE: For “wet set” installation of products such as Marmoleum, inadequate adhesive transfer is the major cause of installation and maintenance related problems. Applying the proper amount of adhesive (using the recommended trowel notch), paying close attention to the open and working times of the adhesive, and rolling the floor covering properly with a 100 pound roller immediately after the material is laid into the adhesive, are essential for achieving a secure bond and a successful installation. Rolling again before leaving the job site each day will give even greater assurance for a successful installation.

INSTALLATIONS IN WET AREAS

For installations where the edges of the flooring material and the adhesive may be subjected to topical water (NOT substrate moisture), Forbo 660 Polyurethane Adhesive is recommended.

Polyurethane adhesives have little or no initial tack, are sensitive to substrate porosity, and set up and curing is directly affected by temperature and humidity. Installer skill and professionalism is important when working with this type of adhesive.

ADHESIVE DESCRIPTIONS

Forbo Flooring L910 Adhesive

- Available in the US and Canada – Maximum concrete moisture vapor emission is 5 lbs. per 1,000 sq. ft. in 24 hrs.
- A solvent free, SBR polymer adhesive recommended for use with Marmoleum on all grade levels of concrete and approved suspended wood floors. Contains antimicrobial protection.
- Available in one gallon and four gallon pails.
- Trowel recommendation: 1/16” x 1/16” x 1/16” square notch.
- Spread rate: Approximately 150 sq. ft. per gallon.
- Material must be installed into wet adhesive.
Open time: 0 - 15 minutes, Working time: 10 - 15 minutes
Note: Times will vary depending on site conditions.
- A 1/16”x1/16” x 1/16” square notch trowel blade is included with each 4 gallon pail.

Forbo Flooring T940 Adhesive

- Available in the US and Canada – Maximum concrete moisture vapor emission is 5 lbs. per 1,000 sq. ft. in 24 hrs.
- A solvent free modified acrylic polymer adhesive recommended for use with Marmoleum Dual Tile on all grade levels of concrete and approved suspended wood floors. Contains antimicrobial protection.
- Available in one gallon and four gallon pails.
- Trowel recommendation: 1/16”x1/16” x 1/16” square notch
- Spread rate: Approximately 150 sq. ft. per gallon.
- Tile must be installed into wet adhesive.
Open time: 0 - 15 minutes, Working time: 10 - 15 minutes
Note: Times will vary depending on site conditions.
- A 1/16”x1/16” x 1/16” square notch trowel blade is included with each 4 gallon pail.

Adhesives

Forbo 660 Polyurethane Adhesive

- Available in the US and Canada – Maximum concrete moisture vapor emission is 3 lbs. per 1,000 sq. ft. in 24 hrs.
- A solvent free, two component adhesive for use with any Forbo floor covering in areas subjected to topical moisture, high traffic, or heavy rolling loads. Forbo 660 adhesive can be used on all grade levels of concrete, metal, and approved suspended wood floors.
- Available in 1/2 gallon, one gallon, and two gallon units.
- Trowel recommendation: 1/32" x 1/16" x 1/32" for vinyl products and Marmoleum tile, or 1/16" x 1/16" x 1/16" for Marmoleum sheet
- Spread rate: Approximately 125 - 175 sq. ft. per gallon.
Follow label instructions for open time and working time.
Note: Times will vary depending on site conditions.
- A 1/32" x 1/16" x 1/32" fine notch trowel blade is included with each unit

Forbo Linotack 414 Adhesive

- Available in Canada only– Maximum concrete moisture vapor emission is 3 lbs. per 1,000 sq. ft. in 24 hrs.
- A synthetic resin dispersion adhesive recommended for use with Marmoleum and Marmoleum Tile on all grade levels of concrete and approved suspended wood floors.
- Available in 3 liter pails or 15 liter pails.
- Trowel recommendation: 1/16" x 1/16" x 1/16" square notch.
- Spread rate: Approximately 40 sq. ft. per liter.
- Material must be installed into wet adhesive.
Open time: 0 - 15 minutes, Working time: 10 - 15 minutes
Note: Times will vary depending on site conditions.

Note: Where the concrete moisture vapor emission exceeds limitations, contact Forbo Flooring regarding the use of Forbo Moisture Limitor

Installing Marmoleum Sheet Flooring

GENERAL INSTALLATION GUIDELINES

- Marmoleum may be installed on approved substrates on all grade levels.
- The permanent HVAC must be operational and set at a minimum of 68° F (20° C) at least one week prior to installation. Acclimate material to jobsite conditions for a minimum of 48 hrs. prior to installation.
- Always conduct moisture tests on all concrete slabs regardless of age or grade level.
- Conduct calcium chloride tests in accordance with ASTM F1869. Concrete moisture vapor emissions must not exceed 5.0 lbs. per 1000 sq. ft. in 24 hrs when using Forbo L910 adhesive, or 3.0 lbs per 1000 sq. ft. in 24 hrs. when using Forbo 414 adhesive (available in Canada only). When moisture vapor emissions exceed these requirements, please request information on Forbo Moisture Limitor.
- Measure the relative humidity in the center of the concrete slab in accordance with ASTM F2170. Relative humidity must not exceed 75%.
- A pH test should be conducted and must not exceed a pH of 10
- Always conduct an adhesive mat bond test. Bond testing will aid in determining the proper working time of the adhesive and identify bonding problems prior to the installation.
- Material should always be visually inspected prior to installation. If there are any questions regarding the quality of material, contact your local Forbo representative or Forbo Technical Services PRIOR to installation. Any costs (including labor) associated with the replacement of material that was installed with visual defects that could have been seen prior to installation are not covered under warranty.
- Use Forbo L910 adhesive or Forbo 414 adhesive (available in Canada only) for flat installations and when coving material.
- Use a 1/16" x 1/16" x 1/16" square notch trowel
- Install rolls and cuts in consecutive order. Do Not Reverse sheets for seaming
- Install one sheet at a time, making sure to place the material into wet adhesive. Roll immediately with a 100 lb. roller and always check for proper adhesive transfer. In order to achieve a secure bond there must be a complete wet transfer of adhesive to the material backing.
- Linoleum will expand slightly in the width and shrink slightly in the length when placed into the adhesive. Proper installation procedures will compensate for this.
- Flat trowel adhesive on the material backing in the area of stove bar marks (double stick), and weigh down after rolling.
- Take pride in your work and be Professional at all times.
- Ensure that all recommendations for subfloor and jobsite conditions are met prior to beginning the installation. Beginning the installation is an implied acceptance of site conditions by the parties involved.

CUTTING AND FITTING SHEETS

1. Cut the required length off the roll, including enough to run up the wall 2-3" at either end.
2. Push the length of the sheet as close to the starting wall as possible, letting the extra length run up the wall at each end.

NOTE: Material should be laid out and positioned so that any seams will fall at least 6" from underlayment joints and/or saw cuts in the concrete.

3. Set the scribes to a minimum of 3/8" more than the greatest distance between the wall and the flooring material. Scribe the shape of the wall onto the flooring. Next, cut the material along the scribe line using a hooked blade knife and holding it at an angle so as to slightly undercut the material. (Fig. 1)



Installing Marmoleum Sheet Flooring

4. Push the fitted sheet tightly against the wall.

5. Using the Forbo seam and strip cutter, trim the factory seam edge. (Fig. 2) A straight edge, utility knife and hooked blade knife may also be used to trim the factory edge. Set straight edge to trim off approximately 1/2". With utility knife, score material about 1/3 the thickness deep. Then with the hooked blade, cut along the score line holding the knife at a slight angle to undercut the edge.

NOTE: Check the instructions included with the seam and strip cutter on how to change the configuration of cutter depending on which product is being installed.

6. Draw a pencil line on the subfloor, lengthwise along the seam edge. (Fig. 3)

7. Lap the material back about halfway.

8. Begin spreading adhesive at the lap point and work back toward the wall (Fig. 4). Spread from the side wall up to the pencil line at the seam edge. Do not spread adhesive 5-6' from the end.

NOTE: The actual open time and working time of adhesives is determined by the ambient air temperature and humidity, the amount of air circulation, the substrate type and porosity, the working characteristics of the adhesive being used, and the trowel notch being used. Adjustments to recommended open and working times might be necessary as site conditions vary. See Adhesives for additional information regarding adhesive open time and working time.

9. The material must be laid immediately into the wet adhesive and rolled with 100 lb. roller. Roll across the width first, then along the length.

NOTE: To ensure proper bonding of the material, it is recommended to roll the material next to the walls with a hand seam roller.

10. Repeat the same procedure on the other half. Again, do not spread adhesive for the last 5-6' from the end.

11. To finish the ends draw a crossline on the subfloor and the sheet near the end (Fig. 5). Draw back the sheet along the pencil line until the end of the sheet lies flat on the subfloor (Fig. 6). Set the scribes or dividers to the distance between the two crosslines (Fig. 7). Scribe the end of the sheet to the wall and cut off. Spread the adhesive and roll. Repeat the procedure at the other end.

NOTE: It is always best to massage the material down into the wet adhesive next to the wall. This not only ensures proper transfer of adhesive but it helps to relax end curl memory that exists in the material.

12. The first sheet should now be fully cut in, adhered and rolled.



2.



3.



4.

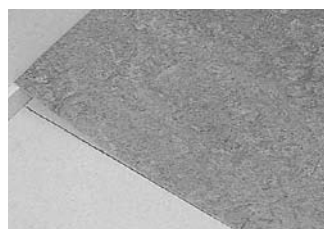

5.

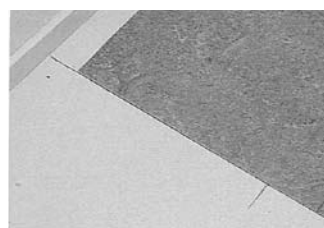

6.

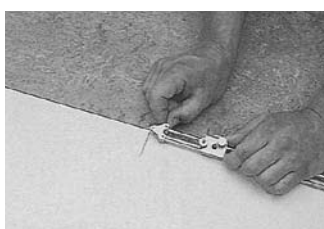

7.

Installing Marmoleum Sheet Flooring

SEAMING PROCEDURE

1. Cut the second sheet to the required length with 2-3 inches extra at either end.

NOTE: DO NOT REVERSE SHEETS. INSTALL ALL LINOLEUM SHEETS IN SAME DIRECTION.

2. Overlap at seam approximately 1 inch.

3. Using the Forbo seam and strip cutter, trim the factory edge on the opposite side to prepare for the next seam.

4. Draw a pencil line down the length of the second sheet.

5. Lap the material back about halfway.

6. Begin spreading adhesive at the lap point and work back toward the wall. Spread from the edge of the first sheet up to the pencil line at the seam edge of the second sheet. Do not spread adhesive 5-6' from the end.

7. The material must be laid immediately into the wet adhesive and rolled with 100 lb. roller.

8. Immediately after material has been laid into the adhesive, underscribe the seam using the short scribes with scribe pin (Fig. 8).

NOTE: Underscribers should be adjusted to produce a net fit at the seam. The seam edges should just meet, with no pressure or fullness. This will compensate for any slight expansion that may occur.

9. Next, cut the material along the scribe line using a hooked blade knife and holding it at a slight angle so as to undercut the material (Fig. 9).

10. Roll seam with hand roller making sure that the flooring material gets into wet adhesive.

11. Repeat the same procedure on the other half.

12. Finish the ends of each sheet in the same manner as the first sheet.

13. Repeat the same procedures for each drop, completing one drop at a time until the job is completed.



8.



9.

Installing Marmoleum Sheet Flooring

14. If cross or butt seams must be made, use the following procedures to allow for any shrinkage that may occur in the length:
- A. Straight edge and cut at the end of the first sheet with a slight undercut.
 - B. Draw a pencil line at end of first sheet, spread adhesive to line, lay in material and roll.
 - C. Overlap second sheet at butt seam approximately 1".
 - D. Fully adhere and roll second sheet as usual except for the last 18" at butt seam, wait 20-30 minutes.
 - E. Spread adhesive for last 18", lay material in, underscribe seam net, cut, roll.

NOTE: In some situations, such as installing material in a narrow hallway where only one piece of material is being used, tubing the material will be necessary. In these situations, close attention should be made in making sure the material is laid into wet adhesive, as well as, being sure to avoid adhesive overlap which could result in a ridge line where the material was folded back. Tubing minimizes the shrinking of the material.

AMBERING

While Marmoleum is maturing in the drying stoves, a yellow cast, termed "drying room yellowing" may appear on the surface. This TEMPORARY yellow cast, caused by the oxidation of linseed oil, occurs intermittently and with varying intensity. Drying room yellowing is most noticeable on the blue and grey shades. When exposed to light, the drying room yellowing will disappear. The process may take only a few hours in bright sunlight, or longer with artificial light. Applying finish before drying room yellowing disappears makes NO difference - it will still disappear with exposure to light.

STOVE BAR MARKS

When curing linoleum, the product is suspended in large loops in the "drying rooms". The top of each loop (Fig. 11-A), known as a pole mark, is cut off and recycled. The bottom of each loop (Fig. 11-B) is called a "stove bar mark" and will appear approximately in the center of each roll (Fig. 12). When installing material with a stove bar mark, simply spread adhesive with the flat side of the trowel in the stove bar mark area on the backside of the sheet (Fig. 13), then spread the adhesive on the floor normally. Remember, you must place the material directly into the wet adhesive. Be sure that when you place the stove bar mark into the wet adhesive that you massage the material down and push the material flat. Roll the material in all directions, starting across the width of the material. Be sure that the stove bar mark is rolled first to avoid trapping the tension on the material. Place weights on the stove bar area until the adhesive has set up.

NOTE: Stove bar marks are not a material defect. When problems occur, they are always directly related to improper installation techniques.

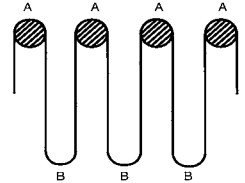

11.

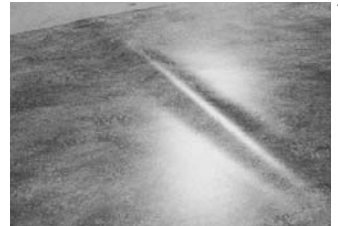

12.



13.

Installing Marmoleum Tile Flooring

General Installation Guidelines

- Marmoleum Dual Tile and Colorex Tile may be installed on approved substrates on all grade levels.
- The permanent HVAC must be operational and set at a minimum of 68o F (20o C) at least one week prior to installation. Acclimate material to jobsite conditions for a minimum of 48 hrs. prior to installation.
- Always conduct moisture tests on all concrete slabs regardless of age or grade level.
- Measure the relative humidity in the center of the concrete slab in accordance with ASTM F2170. Relative humidity must not exceed 75%.
- A pH test should be conducted and must not exceed a pH of 10
- Always conduct an adhesive mat bond test. Bond testing will aid in determining the proper working time of the adhesive and identify bonding problems prior to the installation.
- Material should always be visually inspected prior to installation. If there are any questions regarding the quality of material, contact your local Forbo representative or Forbo Technical Services PRIOR to installation. Any costs (including labor) associated with the replacement of material that was installed with visual defects that could have been seen prior to installation are not covered under warranty.
- Take pride in your work and be Professional at all times.
- Ensure that all recommendations for subfloor and jobsite conditions are met prior to beginning the installation. Beginning the installation is an implied acceptance of site conditions by the parties involved.

LAYOUT

Forbo tile products are installed using conventional tile installation techniques.

It is customary to start from the center of the room. In corridors and small spaces, it may be simpler to work lengthwise from one end, using the center line as a guide.

The center line is drawn as follows: a chalk line is snapped from center of wall A-B(=E) to the center of wall C-D(=F). The center of line E-F is found (M). Draw a perpendicular line through M using the 3:4:5 method to establish G-H. (Fig 1.)

Starting at center point M, measure out lengthwise and widthwise to the walls to make sure you will have at least a half of a tile at the border. Adjust lines E-F and G-H if necessary.

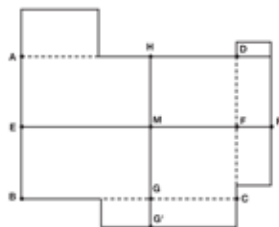

INSTALLATION OF MARMOLEUM DUAL TILE

- Conduct calcium chloride tests in accordance with ASTM F1869. Concrete moisture vapor emissions must not exceed 5.0 lbs. per 1000 sq. ft. in 24 hrs. when using Forbo T940 adhesive, or 3.0 lbs per 1000 sq. ft. in 24 hrs. when using Forbo 414 adhesive (available in Canada only). When moisture vapor emissions exceed these requirements, please request information on Forbo Moisture Limitor.
- Use Forbo T940 adhesive or Forbo 414 adhesive (available in Canada only).
- Use a 1/16" x 1/16" x 1/16" square notch trowel.
- Make sure all material is from the same batch number. Mix tiles from several boxes.
- Do not remove more tile from the box than can be installed in 1 hour.
- Install cartons in consecutive order.
- Install tile in alternating directions (quarter turned).

Installing Marmoleum Tile Flooring

- Install tiles into wet adhesive and roll immediately with a 100 lb. roller. Always check for proper adhesive transfer. In order to achieve a secure bond there must be a complete wet transfer of adhesive to the tile backing.
- Heat welding is optional. Use Marmoweld welding rod only. Do not chemical weld.

ADHESIVE APPLICATION

1. In most cases, the tile should be placed immediately into the adhesive, before the adhesive has had an opportunity to dry. A complete wet transfer of adhesive to the tile backing is essential for a secure bond. When installing over non-porous substrates such as existing flooring, terrazzo, etc., a short open time may be appropriate, but under no circumstances should the adhesive be allowed to dry before placing the tile into the adhesive.

NOTE: The actual open time and working time of adhesives is determined by the ambient air temperature and humidity, the amount of air circulation, the substrate type and porosity, the working characteristics of the adhesive being used, and the trowel notch being used. Adjustments to recommended open and working times might be necessary as site conditions vary. See Adhesives for additional information regarding adhesive open time and working time.

2. Immediately after placing the material into the adhesive roll in both directions with a 100 lb roller.

INSTALLATION

1. Begin laying tile at the center point, ensuring that the tile is laid exactly along the chalk lines. If the first few tiles are not installed correctly, it will affect the entire installation.
2. Because Marmoleum Dual tile must be installed into wet adhesive, do not spread adhesive in an area larger than tile can be installed while the adhesive is still wet.
3. Since it takes time to scribe and cut the border tiles, it is advisable to first spread adhesive only where the full tiles will be laid. When the field is complete, scribe and cut the border tiles before the adhesive is spread. When fitting is complete, adhesive can be spread in the border area and border pieces can be installed and rolled while the adhesive is still wet.

Heat Welding Marmoleum

Heat welding Marmoleum is not always necessary, however, it is always preferred. Heat welding provides for a watertight and hygienic seam, or just for an artistic touch. Marmoleum may be heat welded with either a matching solid color or multi-color welding rod, or a contrasting color welding rod.

The welding rod for Marmoleum is made of a solidified adhesive which is melted and fused, by means of a hot air welding gun, into a joint that has been grooved in the material.

Use only Forbo Marmoweld.

Heat welding should only be done after the flooring adhesive has set up, usually the day following the installation.

It's always a good idea to practice on a scrap piece of material first to assure proper temperature and speed.

NOTE: Forbo's multi-colored welding rod is square shaped instead of round, however all tools and installation procedures are the same as for the standard round solid color rod.

Procedure:

1. Seams should be prepared according to recommended seaming procedures. Gaps in the seam may prevent a quality weld.
2. Groove seam using the Forbo groover (Fig. 1). The depth of the groove on 2.0mm and 2.5mm gauge should be down to the jute fibers but not through them. On thicker gauge materials, groove to a depth of 2.5mm. Grooving to the proper depth is very important to ensure proper adhesion of the welding rod.
3. The ends of the seam, where the Forbo groover cannot reach, must be completed using the hand groover (Fig. 2).

NOTE: The Forbo groover and the Forbo hand groover use the same blade (3.5 mm wide U-shape) to ensure a consistent width groove throughout.

4. Clean all grooves thoroughly.
5. Use only professional quality welding guns that will maintain the proper temperatures. Use 5mm speed tip.
6. Preheat welding gun for several minutes before beginning.
*Optimal temperature setting for linoleum is 350°C (approx 662° F).
7. Cut length of welding rod long enough to weld over half the seam.
8. Position the welding gun near the starting point, insert rod through welding nozzle, and immediately begin welding (Fig. 3).
9. The welding tip should always be parallel to the flooring and directly over the groove. Apply some downward pressure on the tip to help force welding rod into groove.



1.

2.

3.

Heat Welding Marmoleum

10. Determine the correct welding speed by ensuring that the welding rod actually melts into the groove. A small bead should form on either side of the welding rod.
11. While the welding rod is still warm, trim the excess material with the crescent knife and trim plate in one continuous movement (Fig. 4).
12. If there are areas that the welding rod has not properly bonded, a new piece of rod can be melted and fused in and trimmed.
13. Cut a "V" shaped notch at the end of the first section of weld and then repeat the same procedure on the other half, starting from the opposite wall working toward the center. Overlap the welding rod approximately 1" where they join.

NOTE: All welding rod repairs should be made prior to making the final trim.

14. After the rod has cooled to the touch, make the final trim using only the crescent knife (Fig. 5).
15. Minor repairs and smoothing out of the rod may be done using the butane repair tool.
16. The maximum bond strength of the weld is gained after 24 hrs of curing time.

NOTE: When heat welding Marmoleum that joins a vinyl product, you must always use Marmoweld welding rod.

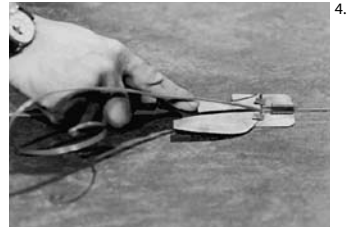

Flash Coving Marmoleum

Flash coving linoleum is done using standard pattern scribing procedures for coving.

Equal attention should be made to wall preparation as is given to floor preparation. The flooring material is only as good as what it covers.

NOTE: Do not cove material over non-porous surfaces (vinyl wallcoverings, marlite, HPL, epoxy paint, etc) without first making sure a proper bond can be achieved.

Cove stick must always be used when flash coving linoleum, and the cove stick must be of rigid type. Soft, flexible types of cove stick will not provide adequate support for the flooring.

Several methods of pattern scribing may be employed when installing linoleum. The installer should always use the method which he is most comfortable with and that offers the best possible results. A common method is using the T-template and the inside corner template (Fig. 6).

After installing the cove stick and cap, and the floor preparation has been completed, cut the pattern felt to within 1/4" of the bottom of the cove stick and tape the felt to the subfloor to prevent movement (Fig. 7). It is important to make hash marks at all seams on the felt to assure proper pattern alignment.

Using a pencil and the T-template (Fig. 8), start in one area and progress around the room pressing the template firmly into the cove stick and under the cove cap. To mark an inside corner, place the template under the cap strip and tight to the inside corner. Mark the base and sides of the template. Repeat on the other side of the corner (Fig. 17). Mark several places on the wall to show the height of the cap. Continue around the room, marking all inside corners. Door casings and other obstacles can be marked with dividers and a square (Fig. 9). Outside corners are done by using a "boot" or mitered corner. Try to put the boot on the least conspicuous side. Mark the cove cap on both sides of the corner (Fig. 10). Allow for about a 1" overhang on the side not being filled. On the boot side of the corner, straight edge the pattern felt 1 1/2" away and parallel to the bottom of the cove stick (Fig. 11). Use a straight edged piece of scrap and place it on the miter of the cove stick and extend it out to the straight edged line on the pattern felt and mark.

The use of set marks on the felt and on the subfloor will help in aligning the material during installation. Make sure to check all marks before removing the pattern felt from the floor.

Place the pattern felt on the linoleum floor covering, align pieces of felt and secure to the flooring with tape (Fig. 12). Place the T-template on the lines drawn on the pattern felt and trace onto flooring to determine the top of the cove cap (Fig. 13).

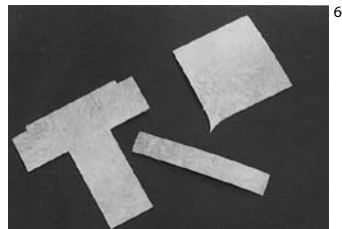

6.



7.

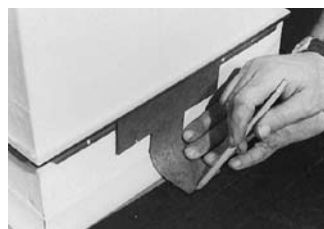

8.



9.



10.

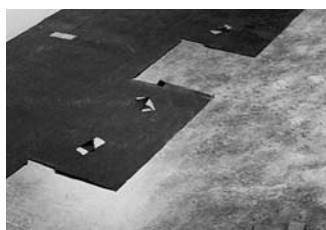

13.



12.



11.

Flash Coving Marmoleum

When marking the inside corners, place the template on the lines made on the felt. Mark the template on the under side of the cove cap and inside the corner. Repeat on the other side. Place the inside corner template on the marks made on the inside corner and trace it with a pencil (Fig. 14). Continue around the pattern, marking and connecting all areas that fit under the cove cap. Mark all door casings and obstacles using dividers and/or a square.



14.

On an outside corner, first mark the piece that extends past the corner and follow the same shape of the radius of the mitered cove stick. Using a square on the straight edge line (1 1/2" from the base of the cove stick) of the pattern where the boot will be placed, cut the linoleum floor covering along the square, starting at the miter and continuing back a distance slightly greater than the height of the cove cap and up the material where the boot will fit in. Make sure it is cut at a 90° angle.



15.

After all marks have been transferred from the pattern felt, cut out the material.

INSTALLING

Set the sheet into the area to be installed, lining up all set marks.

Lap the material back halfway and spread adhesive.

The Forbo Flooring L910 (US) or Forbo Linotack 414 (Canda) adhesive must be spread on the wall and cove stick out onto the floor using the proper notch trowel.



16.

Material must be laid into the wet adhesive and rolled with a 100 lb. roller.

Make sure that the material is tight to the cove stick and tight underneath the cove cap. Tuck corners into place and roll with a hand roller, making sure proper transfer has been achieved.



17.

NOTE: There are several ways to cove material, for further information call Forbo Flooring Support Services Department at 1-800-842-7839 and ask for your Forbo Technical Rep to contact you.

OUTSIDE CORNER (Fig. 15)

Using an outside corner scribe and a scrap of material as a guide, mark the excess material and trim on a bevel (45° angle) to the top of the cove stick (Fig. 16).

Place a straight edge piece of scrap against the miter of the cove stick (Fig. 17). Mark all the way out to the straight edge seam of the floor and trim.

Cut the "boot" using a square, keeping the marbleization of the material running in the same direction as the flooring (Fig. 18). Strip measure for the height of the "boot" fill piece, mark and cut to that height. Cut the length of the "boot" long enough to extend past the corner about 1/2" (Fig. 19).



18.



19.

Flash Coving Marmoleum / Repairs

Put the "boot" in place and use the outside corner scribe to mark from the cove cap down to the cove stick (Fig. 20). Push the material tight into the cove stick and mark the back with a pencil along the radius of the cove (Fig. 21).



Remove the "boot" and with a hook knife held at a 45° angle, cut the material along the scribe line down to the pencil mark at the radius. Turn the material over and continue to cut on a bevel to the inside of the pencil mark to 3/4 of the way down (Fig. 22).



Put the "boot" back into place and use the straight edged scrap to complete the cut to the bottom of the miter (Fig. 23). Remove the "boot" and spread adhesive on the wall and floor. Install the "boot" and roll with a hand roller.

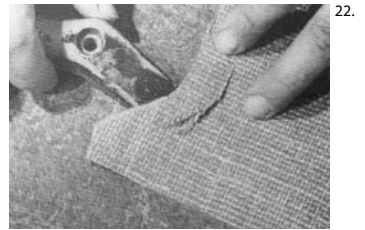

Use the back side of a scrap of material or fine sand paper to remove any burrs on the edges.

REPAIRS

Marmoleum:

- Cigarette burns and small scratches may be repaired using steel wool (double 0 or triple 0). Rub the damaged area, making sure to rub with the grain until damage is removed. Apply floor finish with a clean cloth to repaired area.
- To repair small gouges and voids, a paste made from a small scrap of material may be used. The paste is made by scraping the surface of a scrap piece of material using a paint scraper or knife. Take the scrapings and grind them together to make a fine powder. Mix the powder with white glue to form a paste. Fill the gouge with the paste, making sure to have an excess that, once dry, can be sanded even with the floor surface using steel wool. Apply floor finish to repaired area.
- Large gouges or torn areas may be repaired by plugging with a new piece of material. Plugs in the shape of a fish eye or diamond running with the marbleization will be less noticeable. Match marbleization of plug as close as possible to that of area to be repaired. Install new piece using proper adhesive and roll with a seam roller. Apply floor finish to repaired area.



Tools & Accessories

scribers

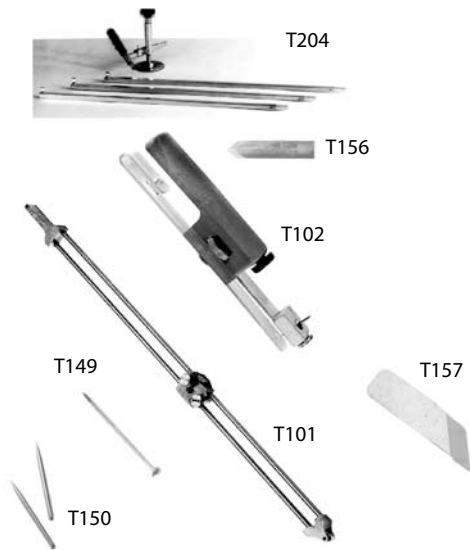

- **T101 Long Scriber** For accurately scribing vinyl & linoleum sheet and tile products. The Long Scriber can be fitted with either a scribe pin or a scribe blade (both included).
- **T102 Short Scriber** For underscribing seams and inlays in vinyl & linoleum sheet and tile products. The Short Scriber can be fitted with either a scribe pin or a scribe blade (both included) and can also be converted to a reverse scriber for use on Marmoleum pre-formed base.
- **T204 Circle Maker & Extensions** Used to scribe or groove circles from 6" to 9'6" in diameter in vinyl & linoleum products. Three extension poles included. The Circle Maker can be fitted with a scribe pin, scribe blade, groover blade, or slotted carpet knife blade (pins and blade not included).
- **T149 Scribe Pins** Replacement pins for the Long Scriber and the Short Scriber (.063" dia. x 1.590" w/brass head). Available in packs of 100 (T149) or 25 (T149.25)
- **T150.25 Scribe Pins** Replacement pins for the Long Scriber, Short Scriber, and Circle Maker (.312" wide x 1.516" long x .052" thick). Package of 6.
- **T157 Scriber Blades** Replacement blades for the Short Scriber (.240" wide x 1.063" long x .052" thick). Package of 6.

groovers & trimmers



- **T105 Thermo Groover** Used in conjunction with heat gun for grooving.
- **T117 Crescent shaped knife**
- **T118 Trim Plate**
- **T133 Forbo Groover** The Forbo Groover is a push groover used for correctly grooving out seams in linoleum & homogeneous vinyl sheets and tiles for heat welding. It uses the T206 blade, the same blade used for the hand groovers for a consistent groove throughout.
- **T201 Bent Hand Groover** Used to finish grooving near walls and for short seams where the Forbo Groover (T133) will not reach (uses T206 blade).
- **T202 Straight Hand Groover** Used to groove seams on coving, corners and hard to reach areas (uses T206 blade).
- **T203 Butane Repair Tool** Used in the repairing and smoothing of welding rod on coving, corners and floor. Comes with 1 straight and 1 anvil shaped tip.
- **T206 Spare Blades for Groover** Used with Forbo Groover (T133), Bent Hand Groover (T201), Straight Hand Groover (T202) and Circle Maker (T204). 10 per pack.
- **T212 X-Acto Knife** For grooving material as well as trimming welding rod on coving and inside and outside corners. Three types of blades available: round (T213), diamond (T214), square (T215).
- **T213, T214 & T215 Blades for X-Acto Knife** Spare blades for X-Acto Knife. 2 per pack.

Tools & Accessories

tapes & moisture limiter



T209



Forbo Flooring Moisture Limitor

T600



Trowel Blades - appropriate Injecto-notch trowel blade is included with adhesive.

cutters & test kits

T15.363

T15.372



T103

T625



T210

- **T209 Double Faced Foam Tape** Used to install cove cap on concrete, metal and sheetrock walls quickly and easily (108' x 1/2")
- **T600 Insertable Blade Trowel** Used in conjunction with trowel blades to spread adhesive when installing resilient floor covering. Blades are included with adhesive. (Also available in a left handed model).
- **Forbo Flooring Moisture Limitor** Forbo Moisture Limitor is a high strength latex based compound formulated to isolate existing adhesives and prevent problems associated with vapor emissions of up to 8 lbs. over a 1,000 square foot area in a 24 hour period when applied by an approved Forbo factory trained installer. Spread rate is approximately 235 to 315 square feet per gallon (two coats), using a 3/8" nap roller or rough surface roller.
- **T103 Seam & Strip Cutter** Designed to score and trim factory edges of linoleum sheet products leaving the appropriate bevel (undercut) in one step, easily and accurately. It can be adjusted to any gauge of material from 2.0 mm to 6.0 mm and it also comes with three spacers to trim 30, 20, 15, 10 mm strips. It uses Roberts cutting blades (T15.36) straight blade and (T15.37) hooked blade.
- **T15.363 Roberts Straight Blade** For use in the Forbo seam and strip cutter (T103). Pack of 10 blades.
- **T15.372 Roberts Hooked Blade** For use in the Forbo seam and strip cutter (T103). Pack of 10 blades.
- **T210 pH Paper** pH paper is used to test the concrete slabs for acidity or alkalinity prior to the installation of the floor covering. If the pH is 10 or above it must be neutralized prior to installation. 100 strips per pack.
- **T625 Calcium Chloride Moisture Test Kit** An absolute must before beginning any installation. Accurately measures the amount of moisture emissions from the slab. Conduct one test for every 1,000 sq. ft. of flooring.

Warranty

LIMITED 10-YEAR WARRANTY

The Forbo Flooring Residential 10-year Limited Warranty

Congratulations on your decision to purchase Forbo Marmoleum flooring. This Limited Warranty offers you protections for a period of 10 years from the date of purchase for the following specific damages that occur during normal household use and conditions. "Normal household use and conditions" is defined as common daily activities in the home.

Under normal household use and conditions, Forbo Flooring warrants for a period of 10 years from original date of purchase that your Forbo Marmoleum floor:

- will be free from manufacturing defects
- will not wear through
- will not permanently stain from traffic stains, including asphalt driveway sealer
- will not permanently stain from rubber or Latex backed mats
- will not fade or discolor from sunlight
- will not rip, tear, or gouge
- will withstand substrate moisture up to five (5) lbs. per 1000 sq. ft. in 24 hours (US) or 3.0 lbs per 1000 sq. ft. in 24 hours (Canada) as tested in accordance with ASTM F1869

Remedy

If your Forbo Marmoleum floor should experience any of these specific problems, then Forbo Flooring will provide you with replacement product equal in quantity and value to the original product purchased. Forbo Flooring will match as closely as possible the color and style of the product in the event the original product is no longer available. This is your sole and exclusive remedy under this Limited Warranty. Forbo Flooring is not liable for the indirect, special, incidental, consequential, or any other damages of any kind, no matter the cause. There are no implied warranties, including any warranty of merchantability and warranty of fitness for a particular purpose. This Limited Warranty is in lieu of all other express warranties and gives you specific legal rights. There are no other warranties of any kind, which extend beyond the description on the face hereof. You may also have other rights, which vary from state to state in the United States or from province to province in Canada.

You should be aware that color, shade, or texture variations between sample or printed color photography and the actual material are not covered. You should also know that Drying Room Ambering is a naturally occurring part of the curing process of the linseed oil. A yellowish film may develop on the surface of the material, distorting the true color beneath it. This film dissipates very quickly with exposure to natural light and reasonably quickly with exposure to artificial light.

Correct installation practices are essential to the performance and appearance of Forbo Flooring floors, so we encourage you to discuss installation matters with your retailer. In order for this Limited Warranty to be in effect, you must ensure that your Forbo Flooring floor is professionally and properly installed using Forbo products. Since proper installation plays an important role in the performance of Forbo Marmoleum floor, THIS LIMITED WARRANTY DOES NOT PROVIDE COVERAGE FOR:

1. Floors not installed in accordance with the recommendations outlined in the Forbo Flooring Installation Manual;
2. Installation problems (including but not limited to improper sub-flooring, poor sub-floor preparation, or use of non-Forbo adhesives);
3. Labor costs;
4. Floors with obvious visible defects; and
5. Construction-related damage.

Correct maintenance procedures are equally important to the performance and appearance of your Forbo Flooring floor. In order for this Limited Warranty to be in effect you must properly maintain and care for your Forbo Marmoleum floor. Therefore, while your homeowner's insurance may cover some of the following, THIS LIMITED WARRANTY DOES NOT PROVIDE COVERAGE FOR:

1. Floors not maintained in accordance with the recommendations outlined in the Forbo Flooring Maintenance Guide.
2. Loss of gloss, scratches, or build-up of dulling film if caused by a lack of proper maintenance;
3. Damages arising from a failure to follow care instructions i.e., cuts, gouges, and scratches due to improper floor protectors);
4. Damages arising from accidents (i.e., fire, flooding, rain, storms, hot items dropped or placed on floor); and
5. Damages arising from misuse or abuse (i.e., sliding heavy objects such as furniture and appliances, dropping heavy or sharp objects, damage from caster wheels, damage from spiked or cleated shoes).

IF YOU HAVE A WARRANTY CLAIM

First, contact your retailer and describe the problem. Hopefully, your retailer can provide you with a solution and start the claims process. If you should need further assistance, please call us at 1-800-842-7839, or write to us at:

Forbo Flooring
8 Maplewood Drive
Humboldt Industrial Park
Hazleton, PA 18201
attn: Consumer Affairs

